

TS-SFP-0680

622Mbps SFP Optical Transceiver, 80km Reach

Features

- Up to 622Mbps data-rate
- 1550nm DFB laser and PIN photodetector for 80km transmission
- Compliant with SFP MSA and SFF-8472 with duplex LC receptacle
- Digital Diagnostic Monitoring:
Internal Calibration or External Calibration
- Compatible with RoHS
- +3.3V single power supply
- Operating case temperature range of
0°C to +70°C (Standard) or -40°C to +85°C (Industrial)



Applications

- SDH STM-4, S-4.1
- SONET OC-12 IR1
- Other optical transmission systems

Description

The SFP transceivers are high performance, cost effective modules supporting data-rate of 622Mbps and 80km transmission distance with SMF.

The transceiver consists of three sections: a DFB laser transmitter, a PIN photodiode integrated with a trans-impedance preamplifier (TIA) and MCU control unit. All modules satisfy class I laser safety requirements.

The transceivers are compatible with SFP Multi-Source Agreement (MSA) and SFF-8472. For further information, please refer to SFP MSA.

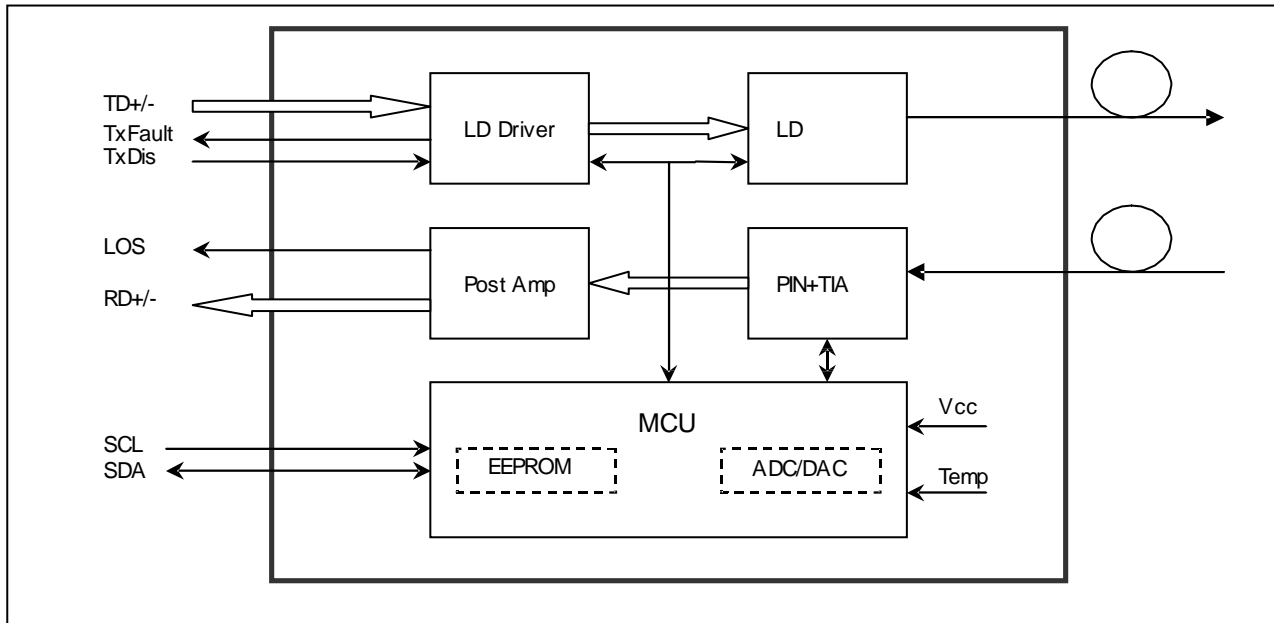
Module Block Diagram

Absolute Maximum Ratings

Parameter	Symbol	Min	Max	Unit
Supply Voltage	Vcc	-0.5	4.5	V
Storage Temperature	Ts	-40	+85	°C
Operating Humidity	-	5	85	%

Recommended Operating Conditions

Parameter	Symbol	Min	Typical	Max	Unit
Operating Case Temperature	Standard	0		+70	°C
	Industrial	-40		+85	°C
Power Supply Voltage	Vcc	3.13	3.3	3.47	V
Power Supply Current	Icc			300	mA
Data Rate			622		Mbps

Optical and Electrical Characteristics

Parameter		Symbol	Min	Typical	Max	Unit	Notes
Transmitter							
Centre Wavelength		λ_c	1480	1550	1580	nm	
Spectral Width (-20dB)		$\Delta\lambda$			1	nm	
Side Mode Suppression Ratio		SMSR	30			dB	
Average Output Power		P _{out}	-3		2	dBm	1
Extinction Ratio		ER	9			dB	
Optical Rise/Fall Time (20%~80%)		t _r /t _f			0.3	ns	
Data Input Swing Differential		V _{IN}	400		1800	mV	2
Input Differential Impedance		Z _{IN}	90	100	110	Ω	
TX Disable	Disable		2.0		V _{cc}	V	
	Enable		0		0.8	V	
TX Fault	Fault		2.0		V _{cc}	V	
	Normal		0		0.8	V	
Receiver							
Centre Wavelength		λ_c	1260		1580	nm	
Receiver Sensitivity					-28	dBm	3
Receiver Overload			-3			dBm	3
LOS De-Assert		LOS _D			-30	dBm	
LOS Assert		LOS _A	-35			dBm	
LOS Hysteresis			1		4	dB	
Data Output Swing Differential		V _{out}	370		1800	mV	4
LOS	High		2.0		V _{cc}	V	
	Low				0.8	V	

Notes:

1. The optical power is launched into SMF.
2. PECL input, internally AC-coupled and terminated.
3. Measured with a PRBS 2²³-1 test pattern @622Mbps, BER≤1×10⁻¹⁰.
4. Internally AC-coupled.

Timing and Electrical

Parameter	Symbol	Min	Typical	Max	Unit
Tx Disable Negate Time	t_on			1	ms
Tx Disable Assert Time	t_off			10	μs
Time To Initialize, including Reset of Tx Fault	t_init			300	ms
Tx Fault Assert Time	t_fault			100	μs
Tx Disable To Reset	t_reset	10			μs
LOS Assert Time	t_loss_on			100	μs
LOS De-assert Time	t_loss_off			100	μs
Serial ID Clock Rate	f_serial_clock			400	KHz
MOD_DEF (0:2)-High	V _H	2		V _{cc}	V
MOD_DEF (0:2)-Low	V _L			0.8	V

Diagnostics Specification

Parameter	Range	Unit	Accuracy	Calibration
Temperature	0 to +70	°C	±3°C	Internal / External
	-40 to +85			
Voltage	3.0 to 3.6	V	±3%	Internal / External
Bias Current	0 to 100	mA	±10%	Internal / External
TX Power	-3 to 2	dBm	±3dB	Internal / External
RX Power	-28 to -3	dBm	±3dB	Internal / External

Digital Diagnostic Memory Map

The transceivers provide serial ID memory contents and diagnostic information about the present operating conditions by the 2-wire serial interface (SCL, SDA).

The diagnostic information with internal calibration or external calibration all are implemented, including received power monitoring, transmitted power monitoring, bias current monitoring, supply voltage monitoring and temperature monitoring.

The digital diagnostic memory map specific data field defines as following.

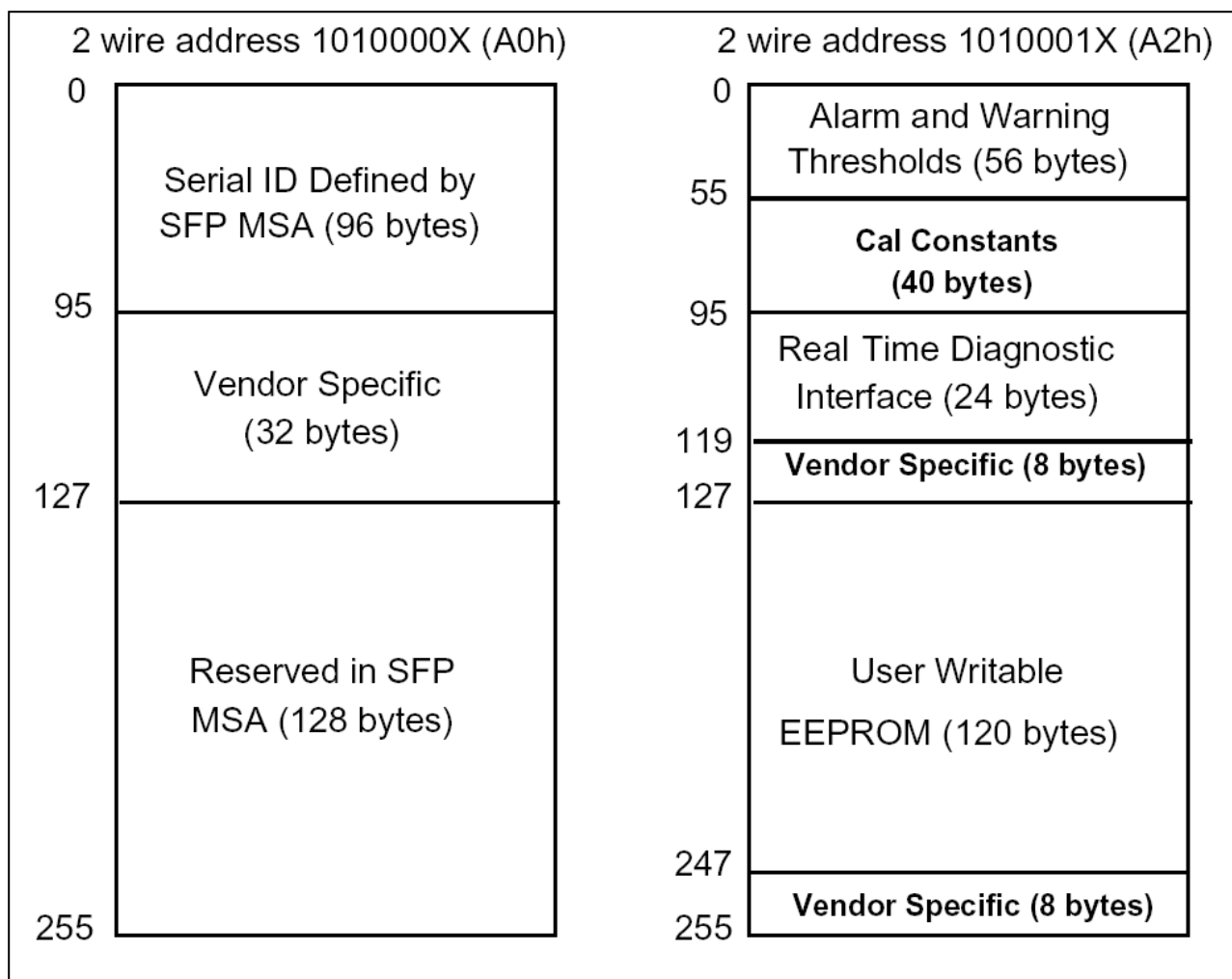

SFP Transceiver Electrical Pad Layout

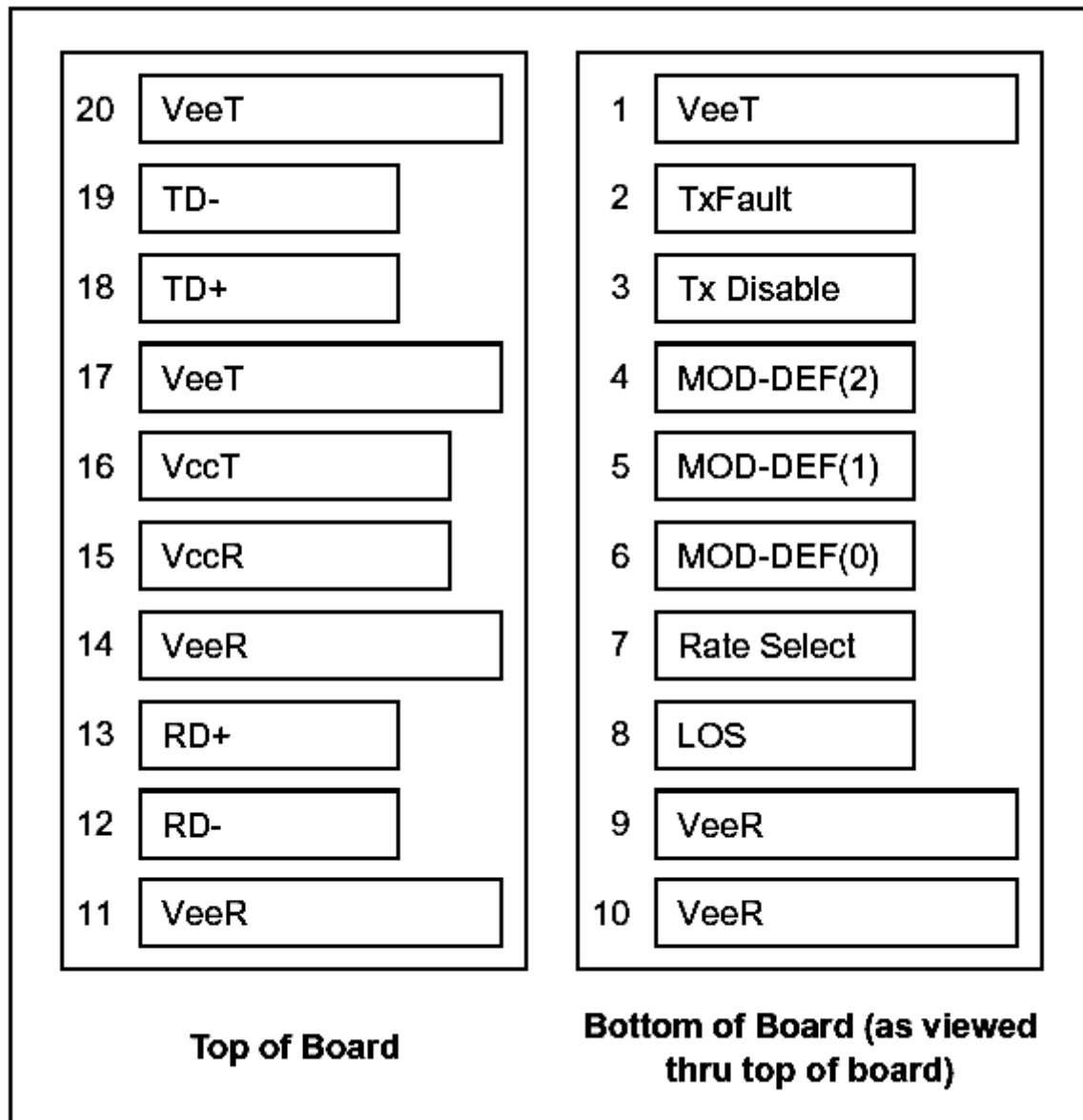

Pin Descriptions

Pin	Signal Name	Description	Plug Seq.	Notes
1	VeeT	Transmitter Ground	1	
2	TX Fault	Transmitter Fault Indication	3	Note 1
3	TX Disable	Transmitter Disable	3	Note 2
4	MOD_DEF(2)	SDA Serial Data Signal	3	Note 3
5	MOD_DEF(1)	SCL Serial Clock Signal	3	Note 3
6	MOD_DEF(0)	TTL Low	3	Note 3
7	Rate Select	Not Connect	3	
8	LOS	Loss of Signal	3	Note 4
9	VeeR	Receiver ground	1	
10	VeeR	Receiver ground	1	
11	VeeR	Receiver ground	1	
12	RD-	Inv. Received Data Out	3	Note 5
13	RD+	Received Data Out	3	Note 5
14	VeeR	Receiver ground	1	
15	VccR	Receiver Power Supply	2	
16	VccT	Transmitter Power Supply	2	
17	VeeT	Transmitter Ground	1	
18	TD+	Transmit Data In	3	Note 6
19	TD-	Inv. Transmit Data In	3	Note 6
20	VeeT	Transmitter Ground	1	

Notes:

Plug Seq.: Pin engagement sequence during hot plugging.

- 1) TX Fault is an open collector output, which should be pulled up with a 4.7k~10kΩ resistor on the host board to a voltage between 2.0V and Vcc+0.3V. Logic 0 indicates normal operation; Logic 1 indicates a laser fault of some kind. In the low state, the output will be pulled to less than 0.8V.
- 2) TX Disable is an input that is used to shut down the transmitter optical output. It is pulled up within the module with a 4.7k~10kΩ resistor. Its states are:
 Low (0 to 0.8V): Transmitter on
 (>0.8V, < 2.0V): Undefined
 High (2.0 to 3.465V): Transmitter Disabled
 Open: Transmitter Disabled
- 3) Mod-Def 0,1,2. These are the module definition pins. They should be pulled up with a 4.7k~10kΩ resistor on the host board. The pull-up voltage shall be VccT or VccR
 Mod-Def 0 is grounded by the module to indicate that the module is present
 Mod-Def 1 is the clock line of two wire serial interface for serial ID
 Mod-Def 2 is the data line of two wire serial interface for serial ID
- 4) LOS is an open collector output, which should be pulled up with a 4.7k~10kΩ resistor. Pull up voltage between 2.0V and Vcc+0.3V. Logic 1 indicates loss of signal; Logic 0 indicates normal operation. In the low state, the output will be pulled to less than 0.8V.
- 5) RD-/+ : These are the differential receiver outputs. They are internally AC-coupled 100 differential lines which should be terminated with 100Ω (differential) at the user SERDES.
- 6) TD-/+ : These are the differential transmitter inputs. They are internally AC-coupled, differential lines with 100Ω differential termination inside the module.

Recommended Interface Circuit

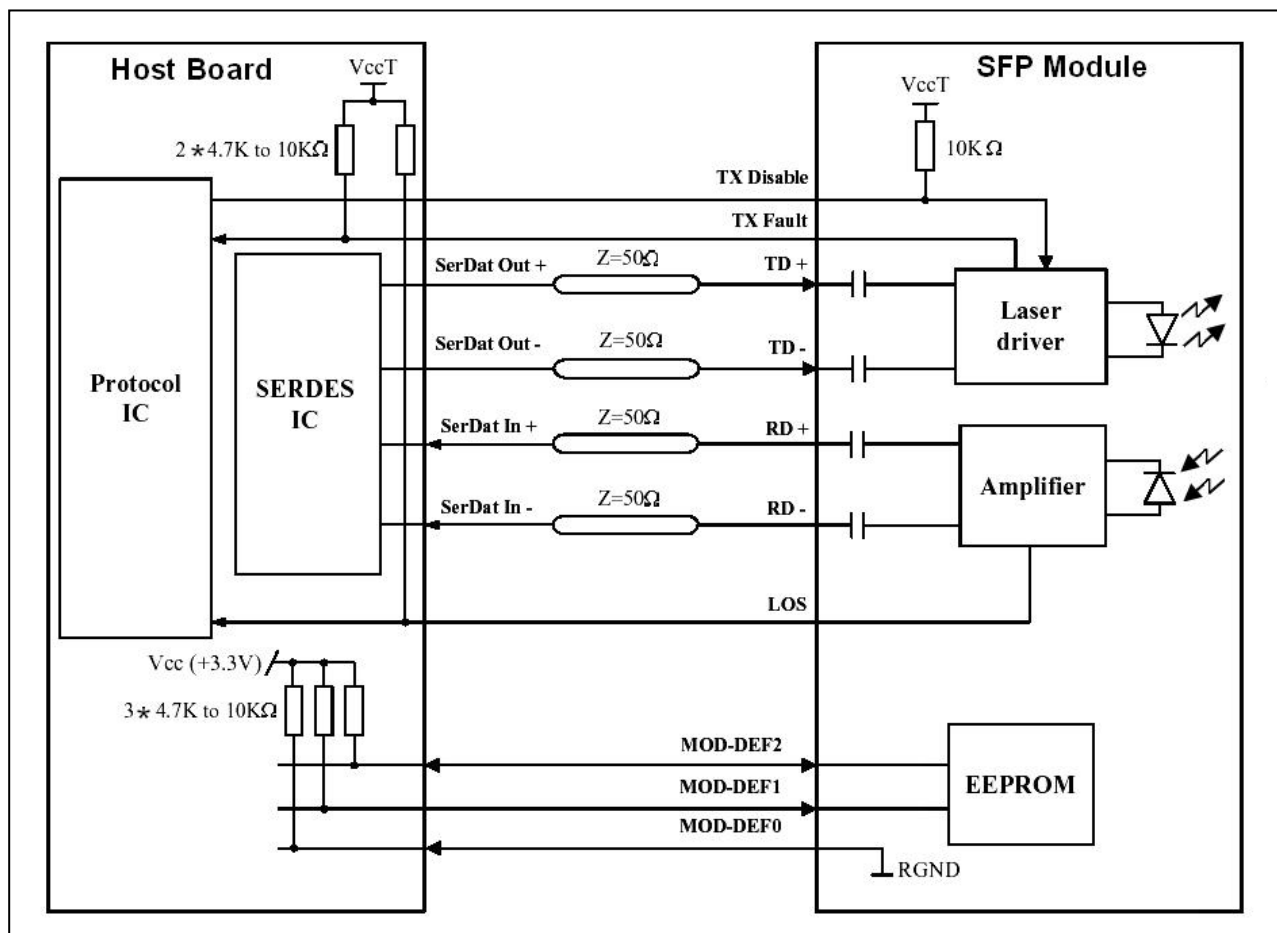

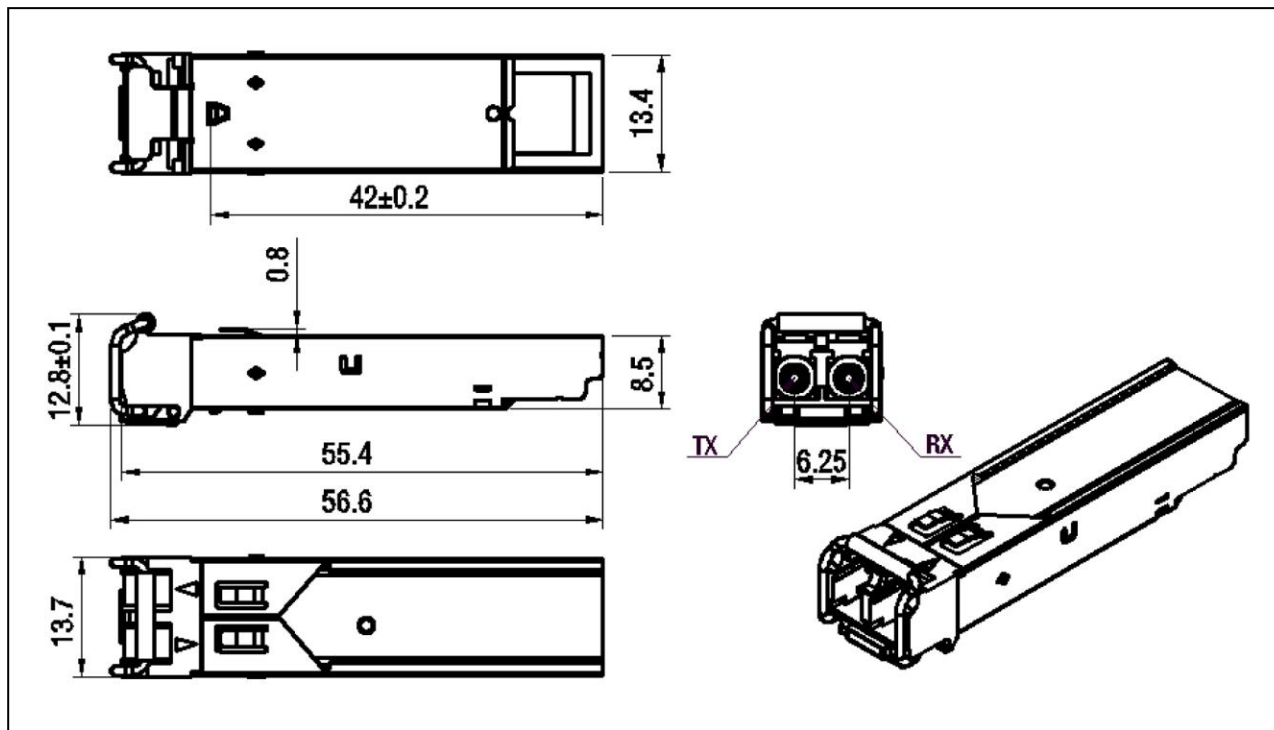
Mechanical Dimensions

Regulatory Compliance

Feature	Standard	Performance
Electrostatic Discharge (ESD) to the Electrical Pins	MIL-STD-883E Method 3015.7	Class 1(>500 V) Isolation with the case
Electromagnetic Interference (EMI)	FCC Part 15 Class B	Compatible with standards
Laser Eye Safety	FDA 21CFR 1040.10 and 1040.11 EN60950, EN (IEC) 60825-1,2	Compatible with Class I laser product. Compatible with TÜV standards
Component Recognition	UL and CUL	UL file E317337
Green Products	2002/95/EC 2005/618/EC	RoHS6

Ordering information

Part Number	Product Description
TS-SFP-0680	1550nm, 622Mbps, LC, 80km, 0°C~+70°C
TS-SFP-0680D	1550nm, 622Mbps, LC, 80km, 0°C~+70°C, With Digital Diagnostic Monitoring
TS-SFP-0680I	1550nm, 622Mbps, LC, 80km, -40°C~+85°C
TS-SFP-0680DI	1550nm, 622Mbps, LC, 80km, -40°C~+85°C, With Digital Diagnostic Monitoring

References

1. Small Form Factor Pluggable (SFP) Transceiver Multi-Source Agreement (MSA), September 2000.
2. Telcordia GR-253-CORE and ITU-T G.957 Specifications.

Important Notice

Performance figures, data and any illustrative material provided in this data sheet are typical and must be specifically confirmed in writing by TONGSION before they become applicable to any particular order or contract. In accordance with the TONGSION policy of continuous improvement specifications may change without notice.

The publication of information in this data sheet does not imply freedom from patent or other protective rights of TONGSION or others. Further details are available from any TONGSION sales representative.

Contact:

sales@tongsion.com

<http://www.tongsion.com>